

PK400AC

Articulated Swing Gate Opener

User Manual

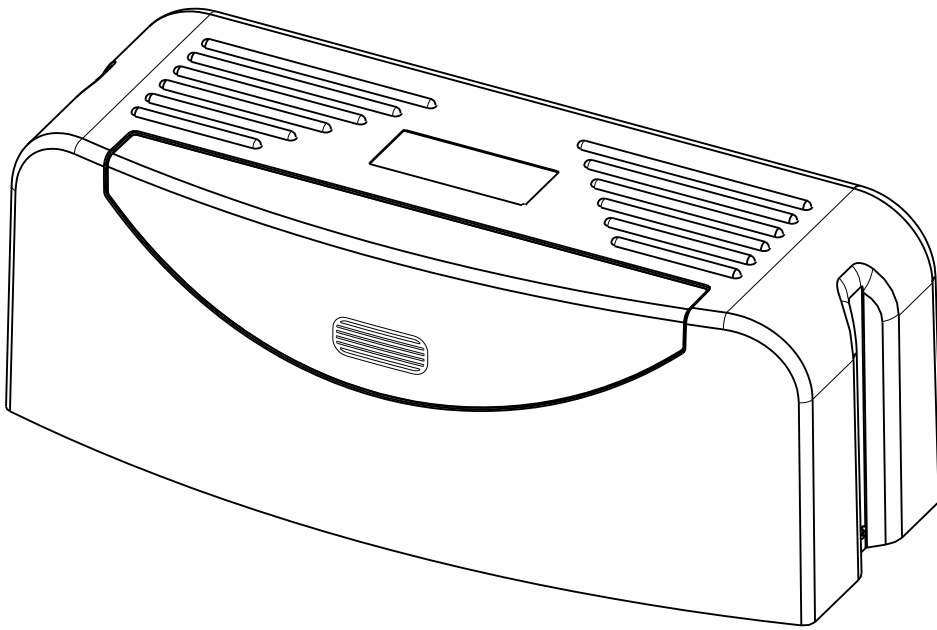

Dear users,

Thank you for choosing this product. Please read the manual carefully before installation and use. Please do not forget to include this manual if you send the product to a third party.

1. Safety Instruction



Please make sure that the power voltage being used matches with the supply voltage of gate opener (AC110V or AC220V); kids are not allowed to touch the control devices or the remote-control unit.

The remote-control unit is single button mode or three button mode (please refer to the instructions for the remote control in accordance with the actual gate opener type). The indicator light on the remote-control unit will flicker when its button is pressed. Main engine and gate can be unlocked with a disengagement wrench and the gate can be manually operated after disengagement.



Please make sure that nobody is around the main engine or gate when the switch is operated.



Please temporarily stop using the product if the main engine needs to be repaired or regulated. The installation and maintenance of the product must be carried out by professionals.

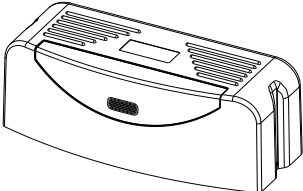
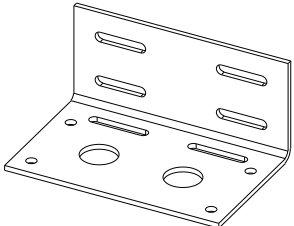
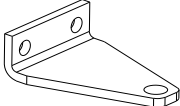
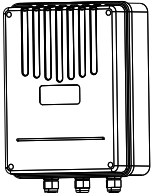
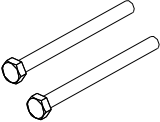
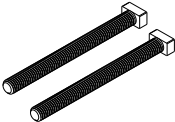
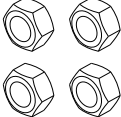
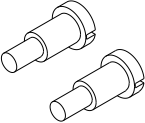

Please read this manual carefully before installing, using, maintaining or repairing it. Without following this manual, any injury or property losses caused by improper use or unauthorized modification is out of the responsibility of our company.

2. Packing List Packing List (standard)

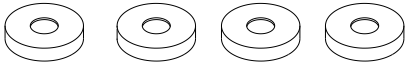
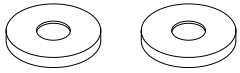
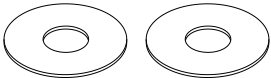
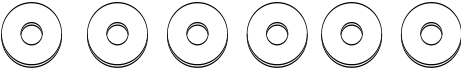
No.	Picture	Name	Quantity
1		Main engine	2
2		Mounting base plate	2
3		Front mounting bracket	2
4		Control box	1
5		Hexagon head bolt M8x115	4
6		T-head bolt	4
7		Nut M8	8
8		Mounting screw	4
9		Self-locking nut M8	4

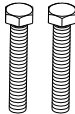
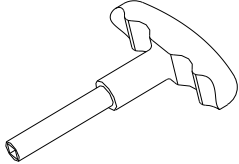
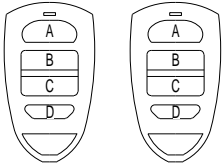
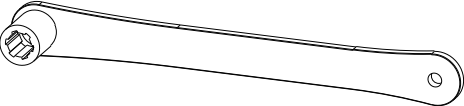
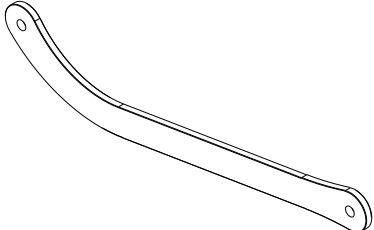
No.	Picture	Name	Quantity
10		Anti-friction washer (thick)	4
11		Anti-friction washer (thin)	2
12		Cam washer	2
13		Flat washer $\phi 8$	10
14		Spring washer $\phi 8$	10
15		Hexagon head screw M8x30	2
16		Manual release bar	1
17		Remote control	2
18-1		Crank arm	2
18-2		Connecting rod	2

2. Packing List (optional)

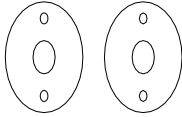
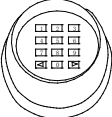
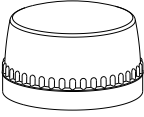
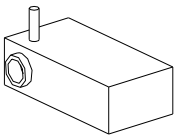
No.	Picture	Name	Quantity
1		Infrared sensor	1
2		Wireless keypad	1
3		Alarm lamp	1
4		Electronic lock	1

3. Technical Parameters

Model	PK400AC
Power supply	AC220V/50Hz, AC110V/60HZ
Motor power	260W
Opening time	9°/s~11°/s
Maximum weight of single gate	400Kg
Distance for remote control	≥30m
Remote control mode	Single-button mode/Four-button mode
Limit switch	Mechanical limit switch
Noise	≤58dB
Working duty	S2, 15min
Recording of up remote controls	25
Frequency	433.92 MHz
Working temperature	-20°C ~ +70°C
Weight	25.70Kg

4. Installation Guide

PK400AC swing gate opener is applicable to single leaf gate weight less than 400kg, and length of the single leaf swing gate less than 2.5m. The drive mode adopts the worm and worm gear to combine the pinion transmission. This gate opener must be installed inside the enclosure or yard for protection.

4.1 Installation drawing

Figure 1 and Figure 2 are the automatic swing gate system installation and the installation relation between the main engine and principal accessories.

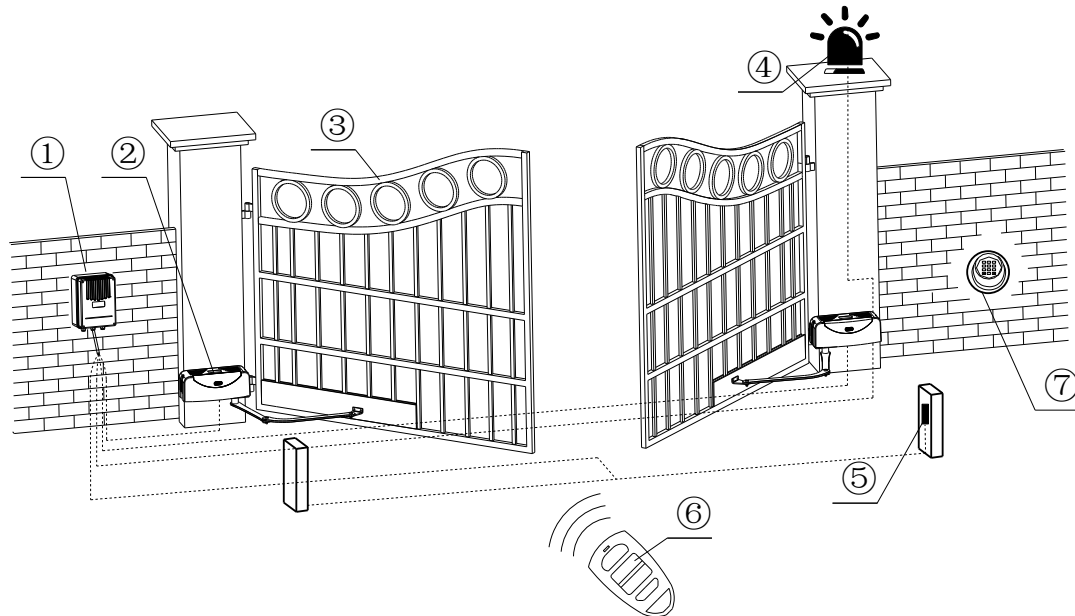

Figure 1

- ①. Control box; ②. Gate opener; ③. Gate; ④. Alarm lamp (optional);
⑤. Infrared sensor (optional); ⑥. Remote control (optional); ⑦. Wireless keypad (optional)

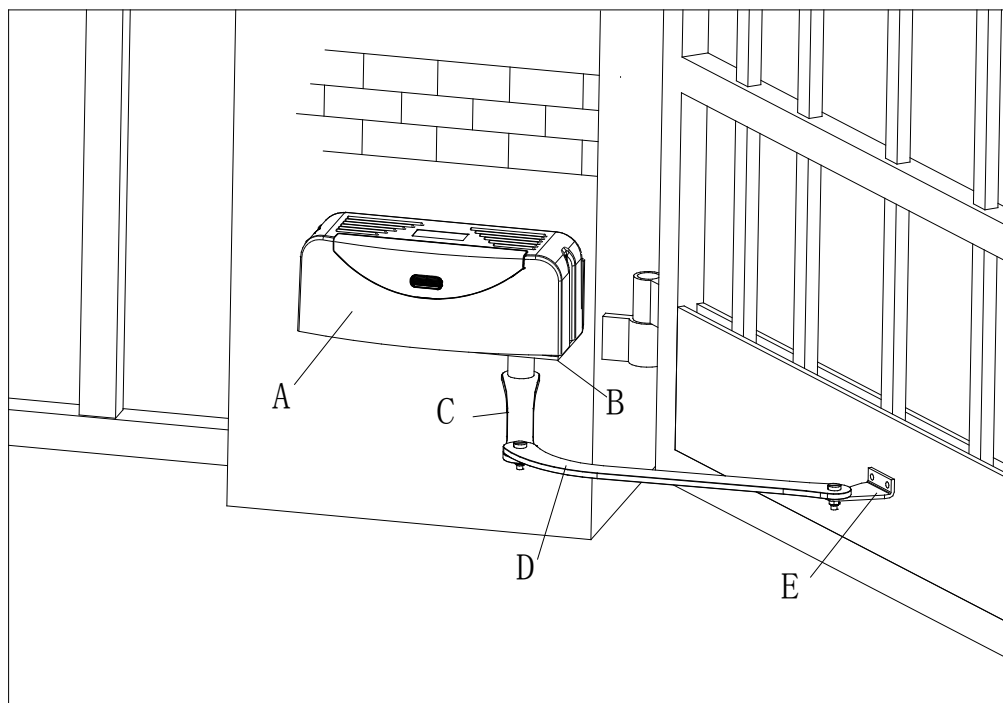

Figure 2

- A. Main engine; B. Mounting base plate; C. Articulated arm parts;
D. Connecting rod; E. Front mounting bracket.

4.2 Size of main engine and accessories

4.2.1 Size of main engine

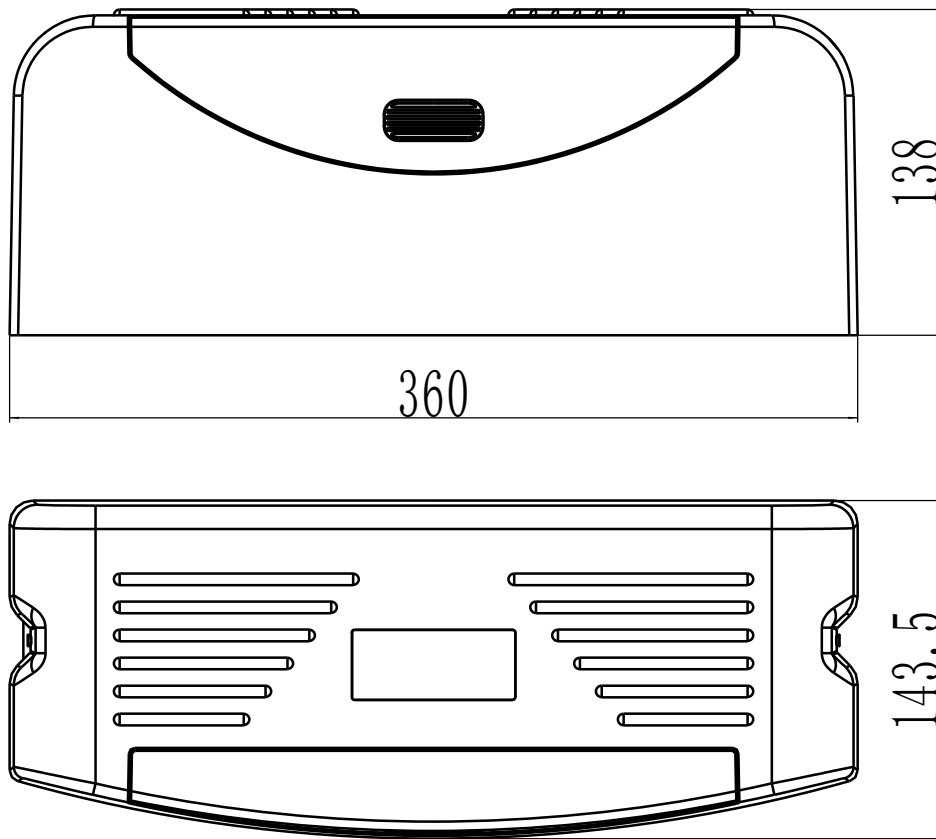

Figure 3

4.2.2 Size of front mounting bracket

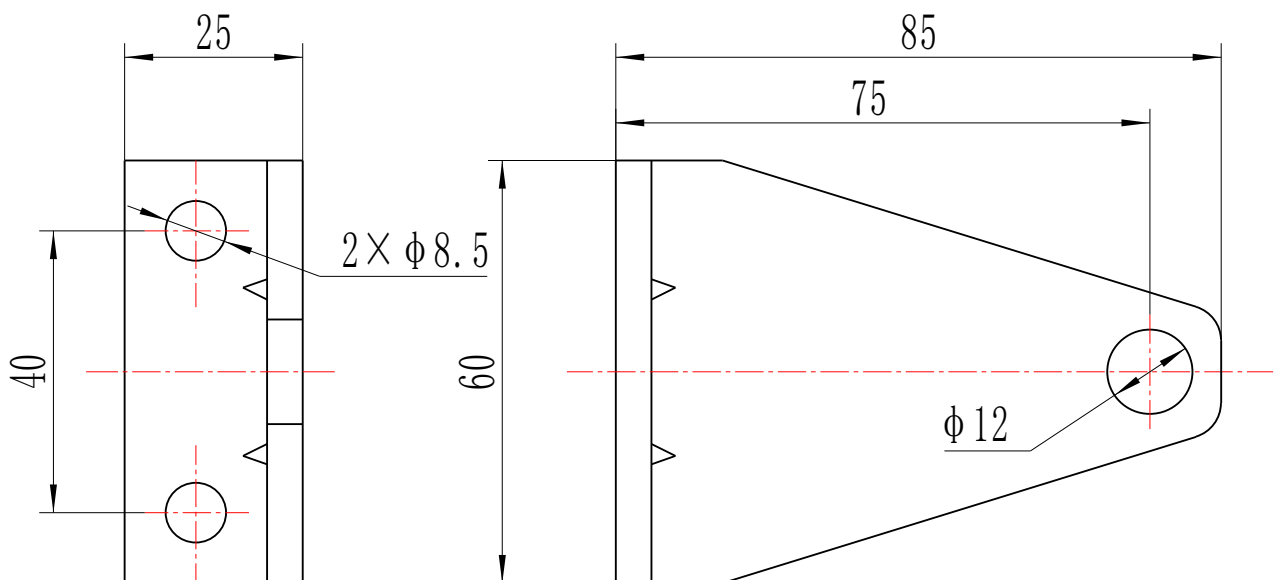

Figure 4

4.2.3 Size of mounting base plate

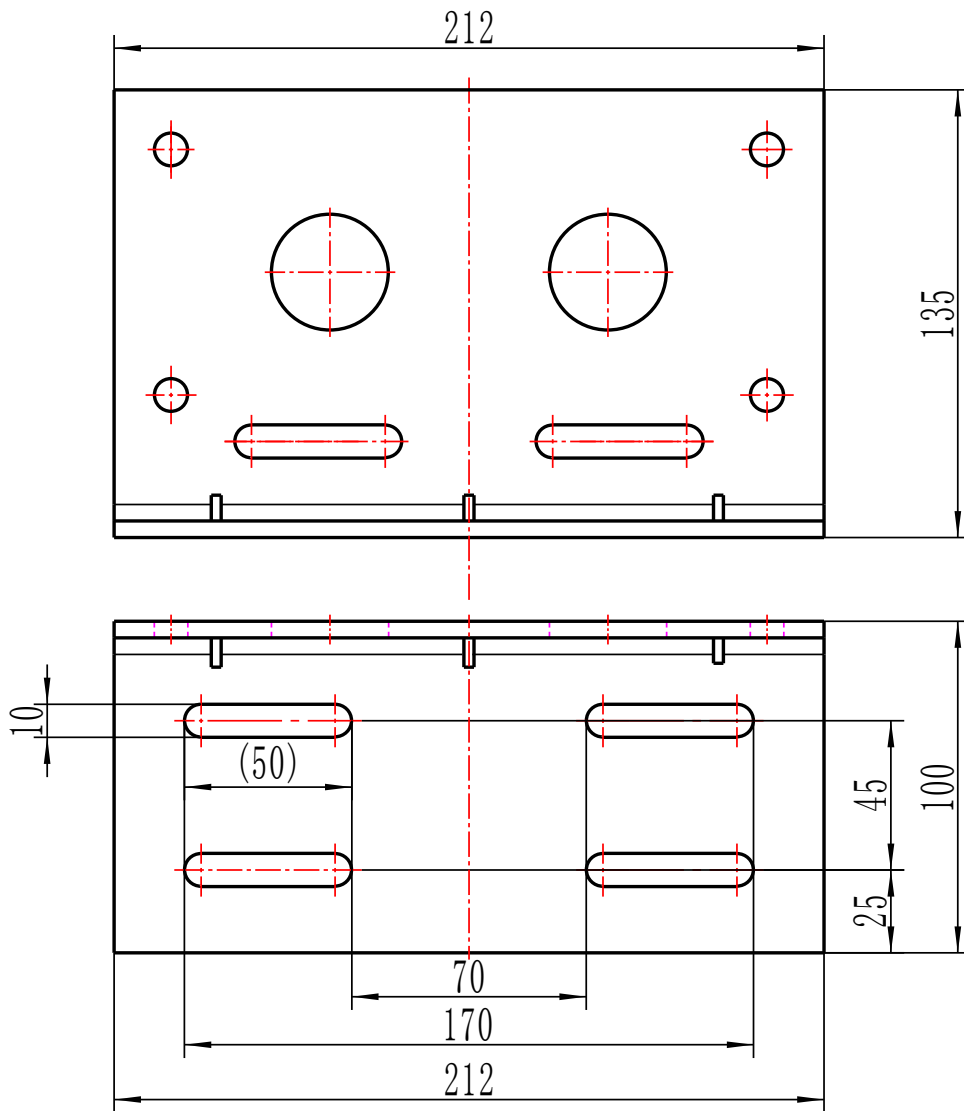

Figure 5

4.3. Installation procedures

4.3.1 Installation drawing for main engine

The two engines should be respectively installed at both sides of the gate. The installation relation between the housing, main engine and mounting plate is shown in Figure 6. Take the left side main engine as the example for detailed description of installation method. For installation method of the right side engine, please refer to the left side one.

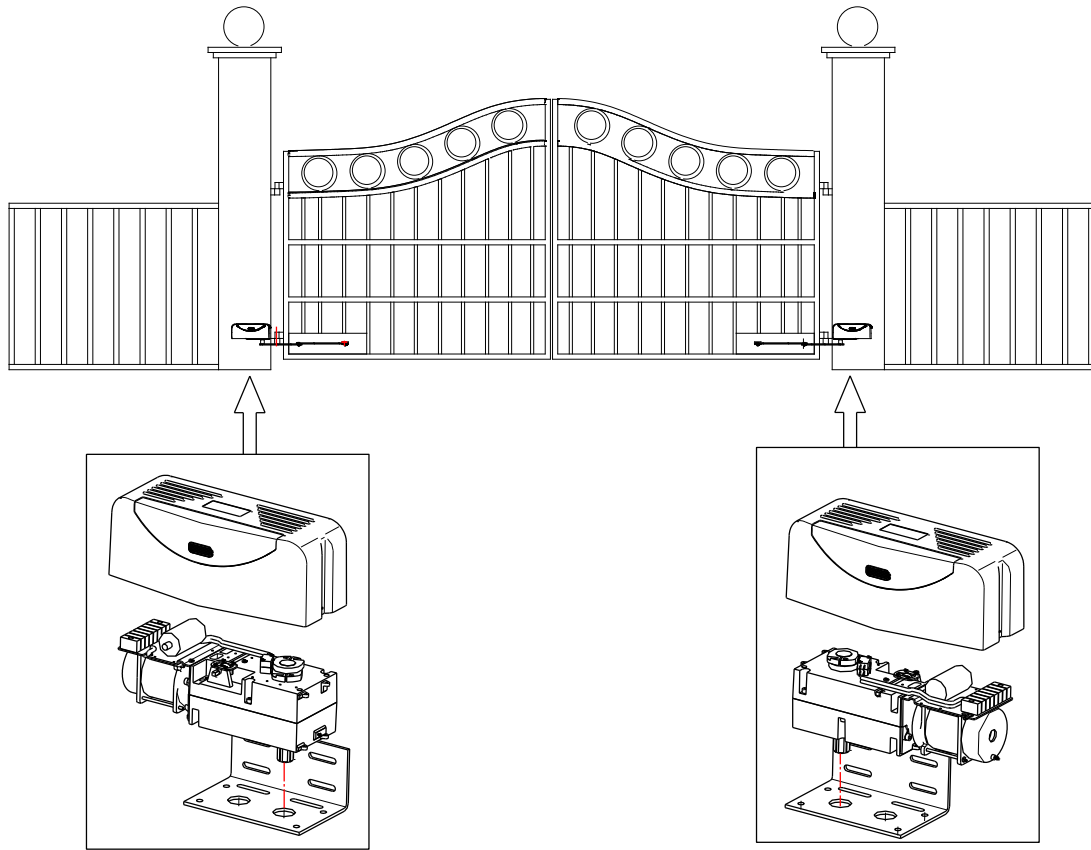

Figure 6

4.3.2 Preparation work before installation

- a) Before installing the door opener, please make sure the door is correctly installed, which can be manually operated easily. Remove the plastic cover on the main engine and the mounting base plate before installation. Keep the relevant fasteners properly;
- b) To install the electric lock if necessary, please make sure that the distance between the bottom of the door and ground should be 40-50mm. If electric lock is unnecessary, the distance between the bottom of the door and ground should be ≥ 20 mm.

Cable installation

Please prepare the fasteners for connecting mounting plate to the wall according to different installation environment, and the power cable for main engine (the number of power supply cable cores for each main engine should not be less than 4 PCS, the sectional area of cable core should not be over 1.5mm^2), the limit switch cable for main engine (the number of limit switch cable cores for each main engine should not be less than 3 PCS, the sectional area of cable core should be over 0.75mm^2), the power cable for control box (the number of cable cores should not be less than 3 PCS, the sectional area of cable core should be over 1.5mm^2). The length should be determined by the user according to the situation on installation spot.

Note: The pipe outlet should be downwards to avoid rainwater entering the pipe along the cable.

Mounting brackets fixation

In order to install the PK400AC main engines firmly, recommend to use the expansion screws to fix the mounting brackets.

4.3.3 Mounting base plate installation

The installation position of the mounting plate is shown in the Figure 7. The recommended mounting dimension as below:

Dimensions	Recommended data (mm)
A	$20 < A < 100$
B	$B > 100$

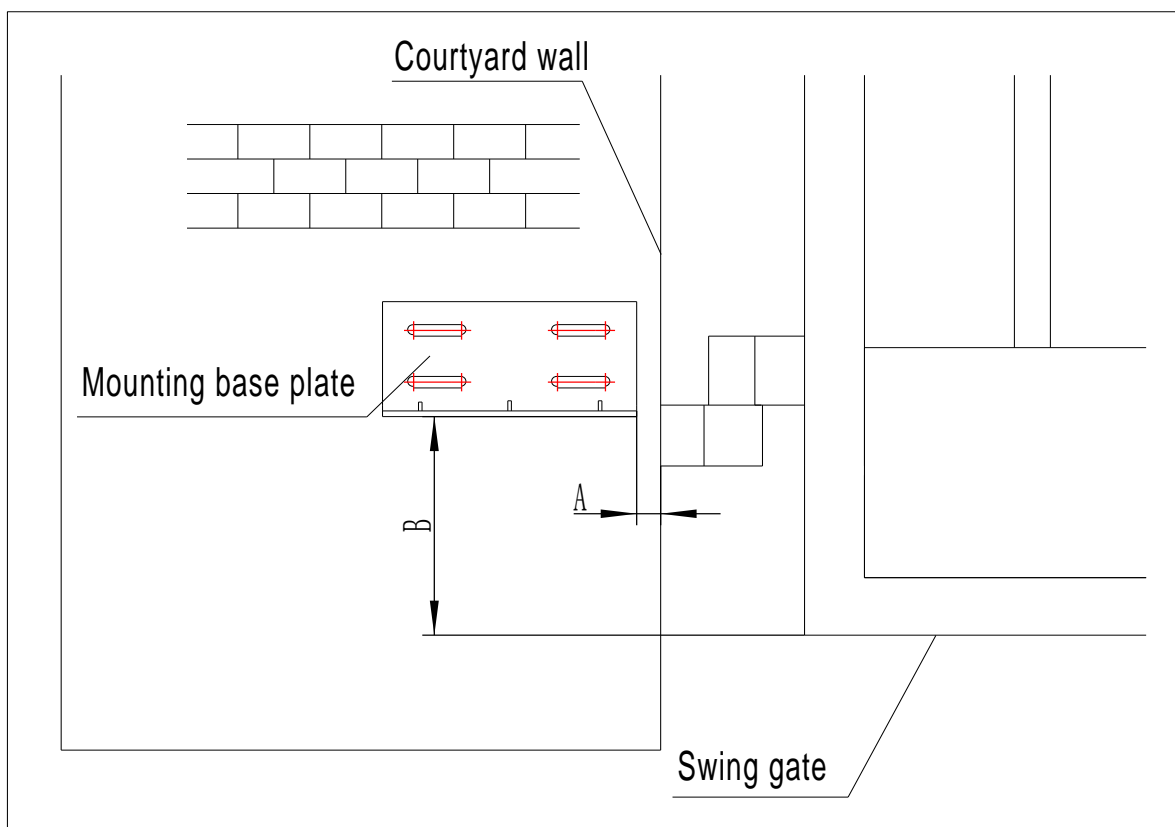

Figure 8



Warnings

- Before installing the main engine, please make sure that the main engine and components are in good mechanical performance and the door can be manually operated without any stuck.
- Please note that one control unit can drive one main engine or two main engines.
- Earth leakage circuit breaker must be installed in where the gate movement can be seen. The minimum mounting height of control box is 1.5m to avoid being touched by children.
- After installation, please check whether the mechanical performance is good or not, whether gate movement after manual unlocking is flexible or not, whether the installation for infrared sensor (optional) is correct and effective.

4.3.4 Main engine installation

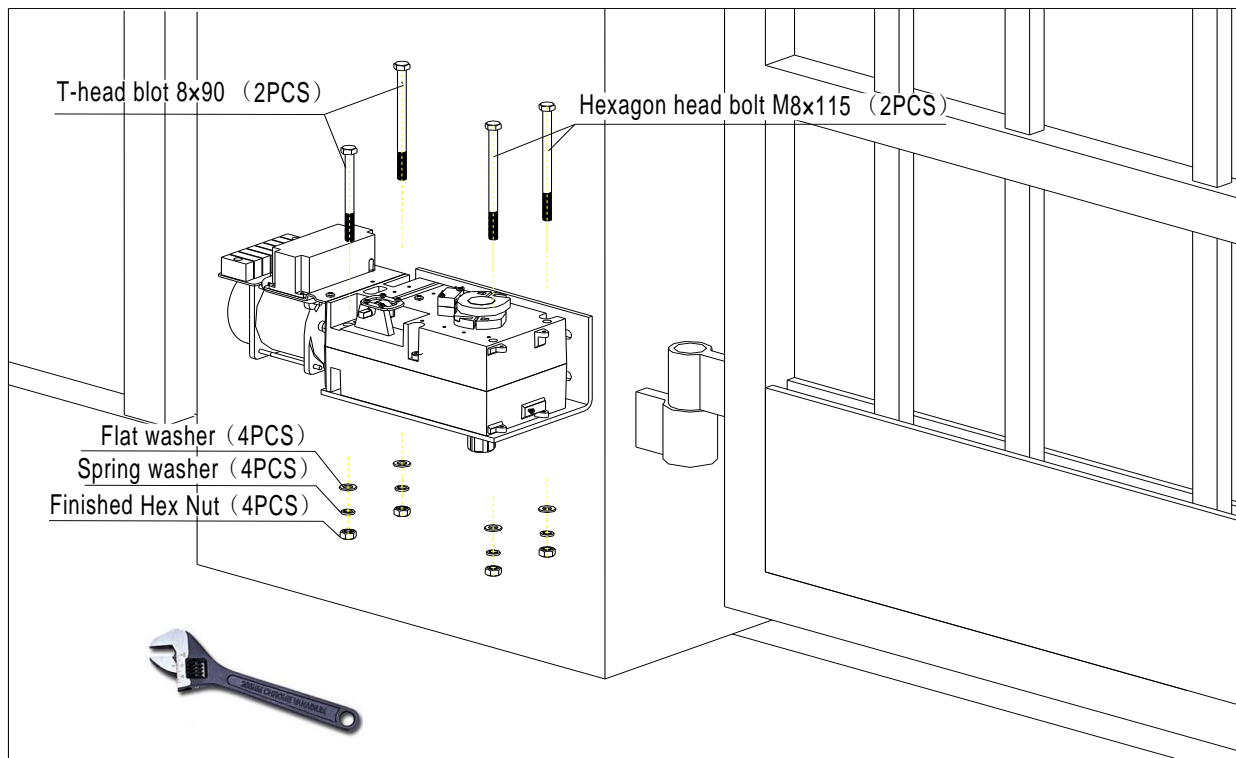

Figure 9

4.3.5 Crank arm and connecting rod installation

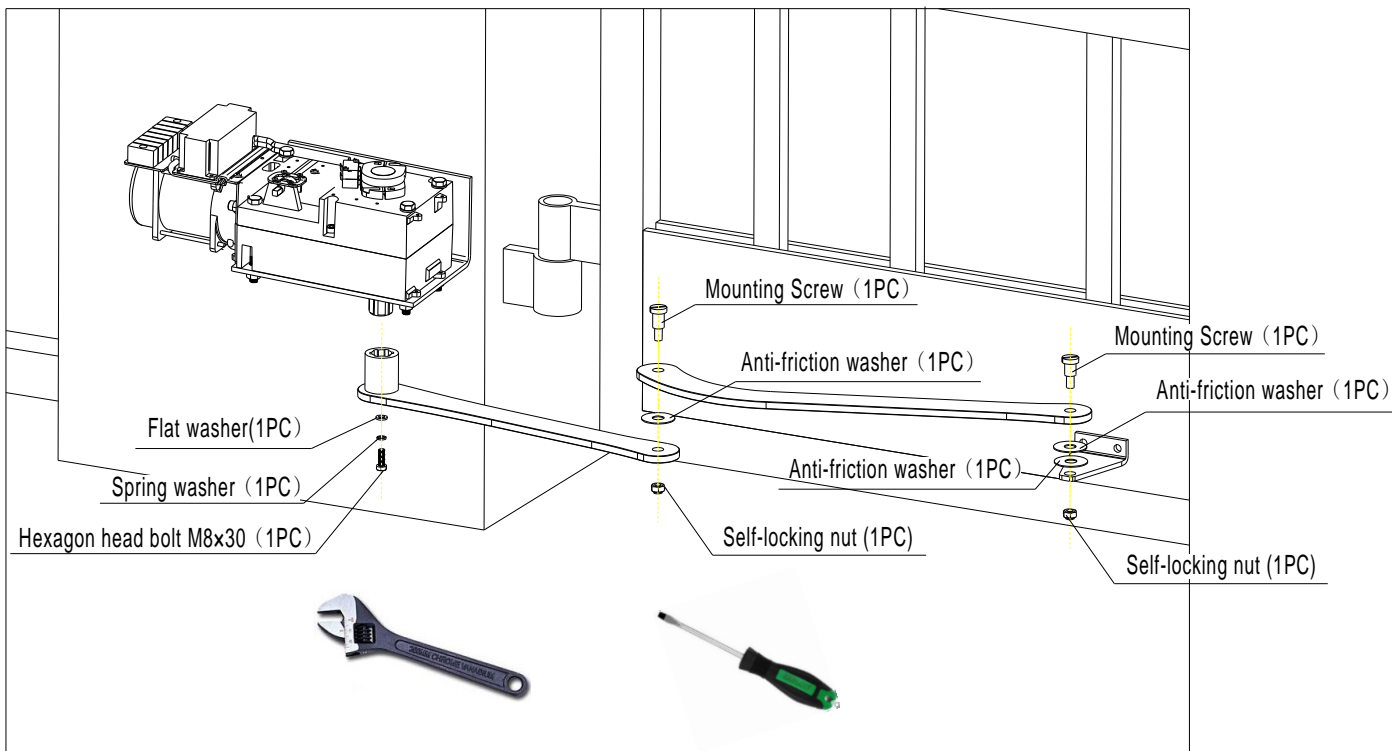

Figure 10

Note: Please use gradienter to detect before fixing, make sure that the crank arm and the connecting rod are on the horizontal line.

Please unlock the two main engines with the manual release bar before installation. The unlock method is: use manual release bar to rotate the release rod counterclockwise (as shown in the Figure 11) till the block of disengagement is switched to the rightmost position. Then put the crank arm on the output shaft (spline shaft) and the crank arm can be rotated easily.

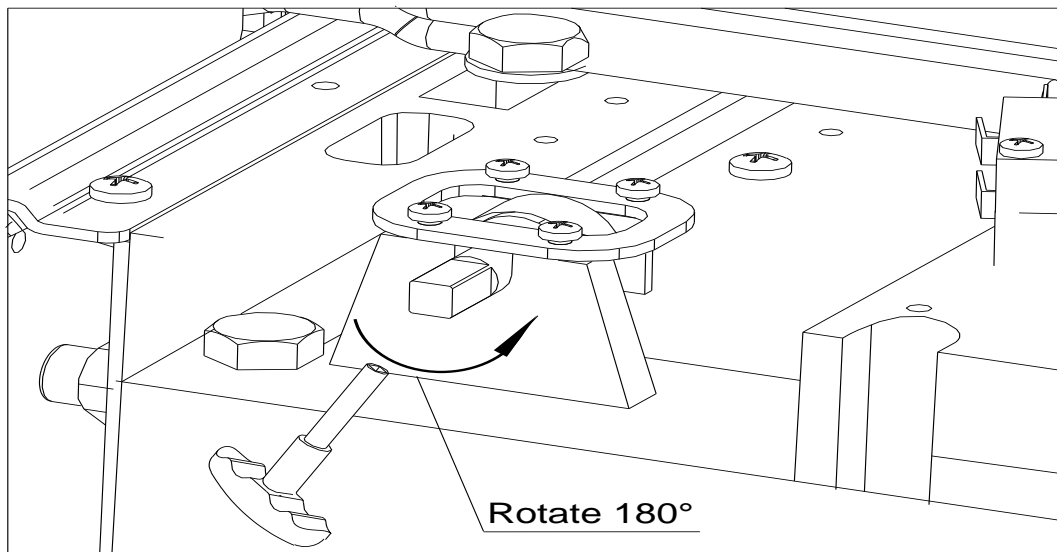

Figure 11

4.3.6 Front mounting bracket installation

- a) Adjust the door to the fully closed position;
- b) Keep the installation plane of front mounting bracket and the door in good fit. Rotate the crank arm to regulate the position of the front mounting bracket; $600 < E < 700$ mm is recommended for the measurement E (in the Figure 12); meanwhile mark the mounting hole center of the front mounting bracket on the gate frame;
- c) Punch holes on the gate frame according to the marked position with electric hand drill or similar tools. Make sure the hole pitch is 40 ± 0.5 mm;
- d) Fasten the front mounting bracket to the door with fasteners.

Note: the fasteners should be provided by users themselves.

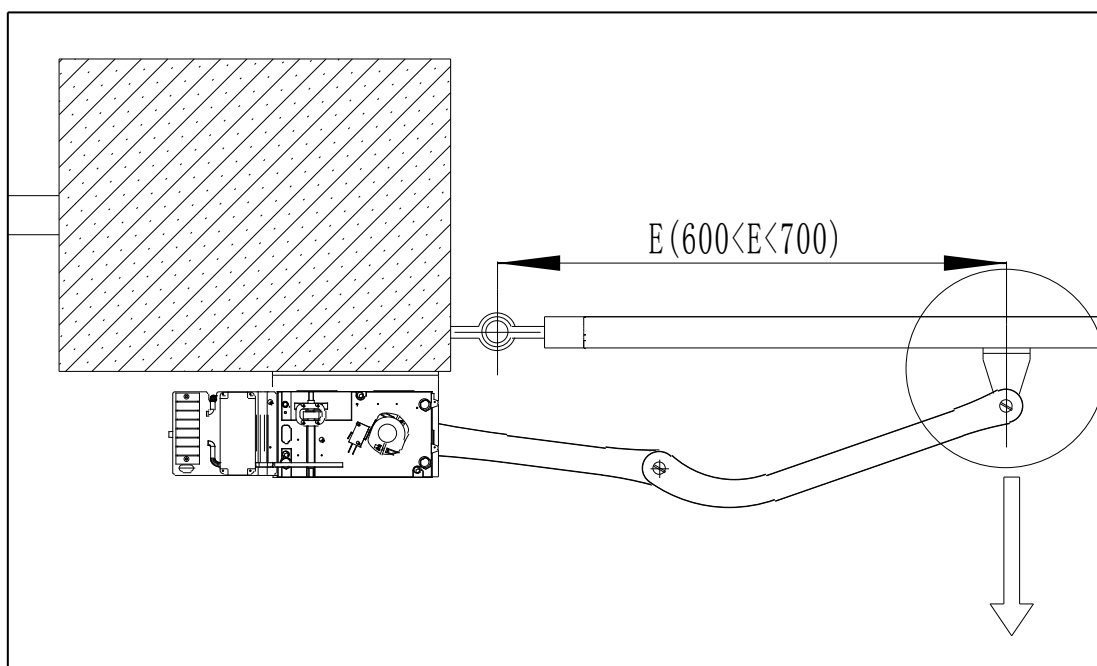

Figure 12

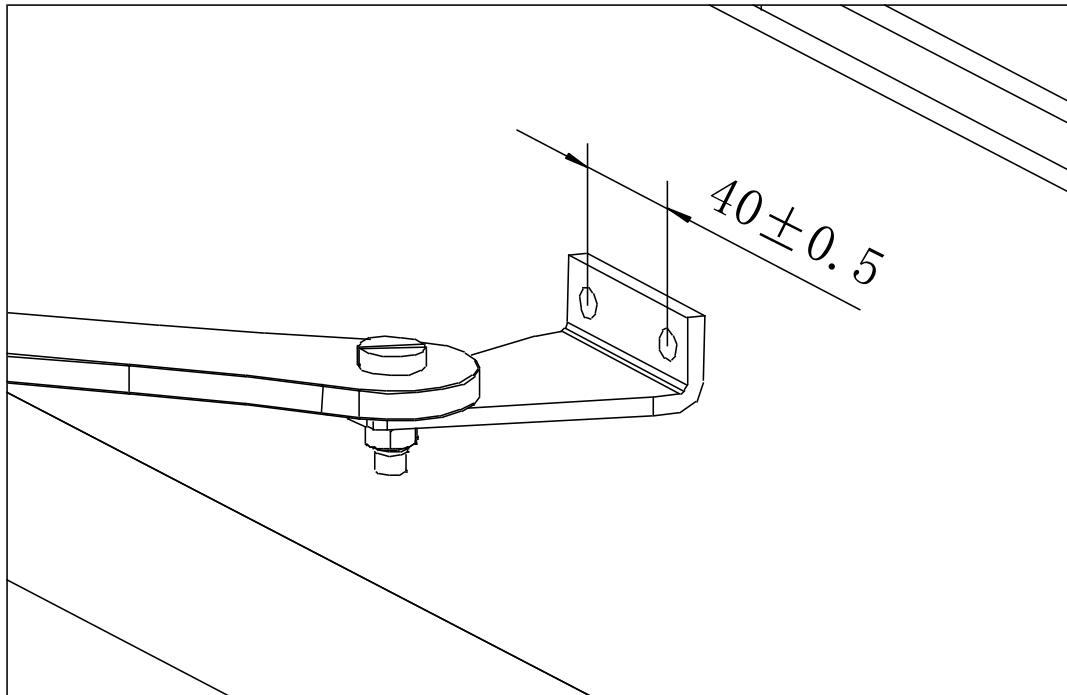

Figure 13

4.3.7 Adjust the position of limit cam

The installation position of limit cams is shown in the Figure 14. Please adjust according to the following steps:

- a) Adjust the door to the fully closed position. Loosen the screws in two limit cams with screwdriver and then take out the external limit cam 2;
- b) Rotate limit cam 1 counterclockwise so that the contact point between micro switch shrapnel and cam moves from the minor diameter to the major one; stop rotating after contact point of the micro switch is pressed together with a click sound; then fasten the fastening screws of cam with screwdriver;
- c) Adjust the gate to the fully opened position and install the cam 2. Rotate the cam 2 clockwise so that the contact point of micro switch shrapnel and cam moves from the minor diameter to the major one; stop rotating after contact point of the micro switch is pressed together with a click sound; then fasten the fastening screws of cam with screwdriver.

Note: After the first regulation of cams' positions, please connect the relevant circuits of the gate opener to the power, and run the complete travel to check if the door meets the standard in its fully opened or fully closed position; if not, the positions of cams' might need to be fine-turning repeatedly.

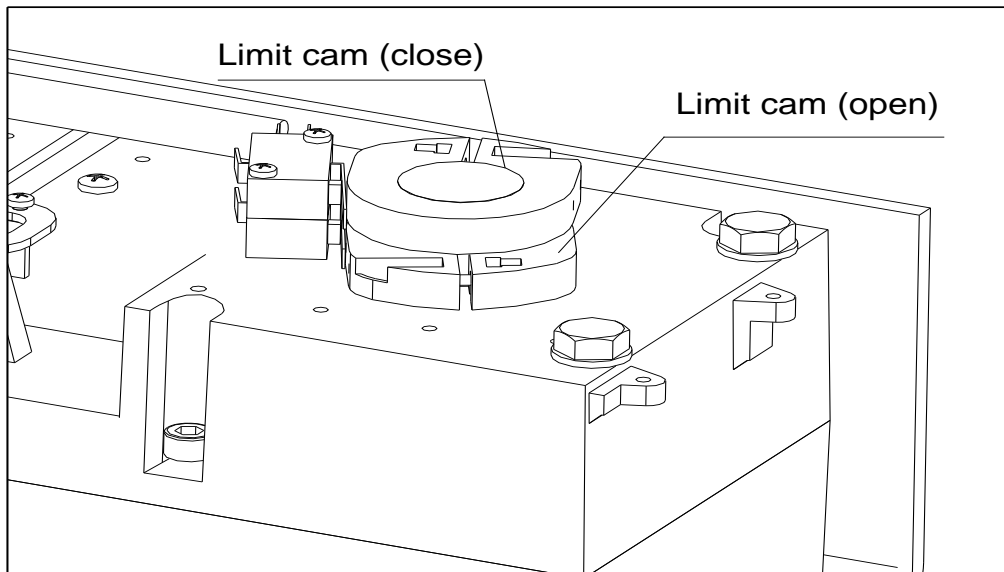

Figure 14

4.3.8 Manual operation

In case of power failure, please insert the provided manual release bar into the release rod (as shown in Figure 15), counterclockwise rotate it 180 degrees, after which gate can be opened or closed manually.

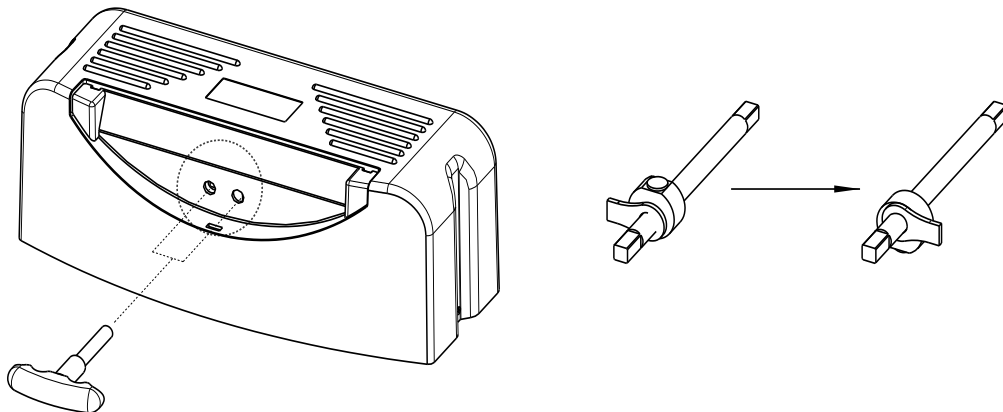

Figure 15

4.3.9 Control box installation

The outline of the control box and the size of mounting holes are shown in Figure 16. Punch on the wall according to the size of mounting hole; Remove the upper cover and fasten the base (with control panel) of the control box to the wall. The installation height should be over 1.5 meters. If it is installed outside, please note to take waterproof measures.

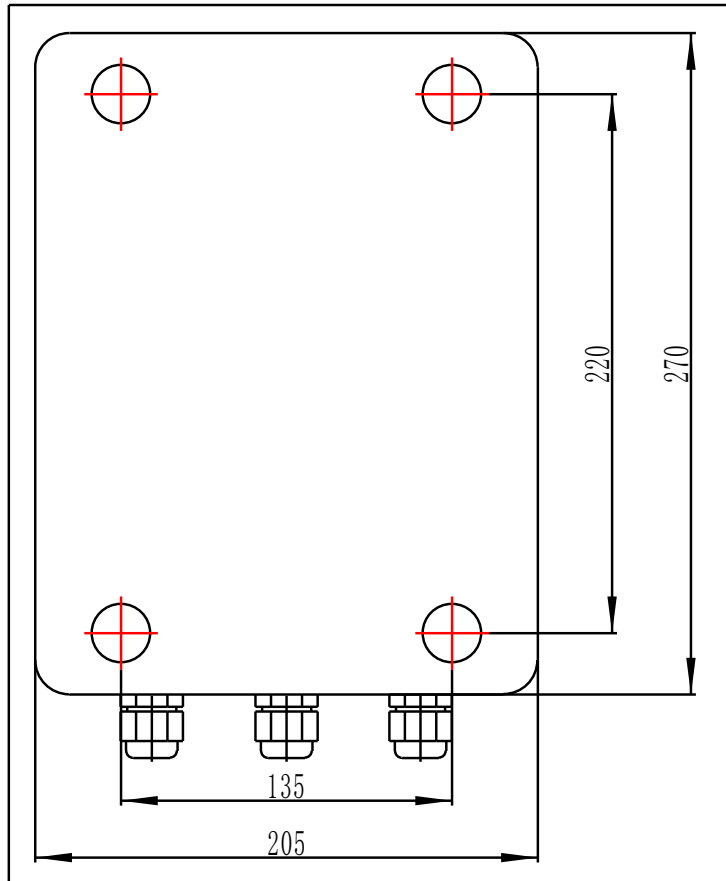

Figure 16

5. Installation and Debugging of Control System

5.1 Wiring

Wire the left and right main engine according to the diagram shown in Figure 17. Please refer to Figure 18 to Figure 21 for the wiring method of other optional accessories

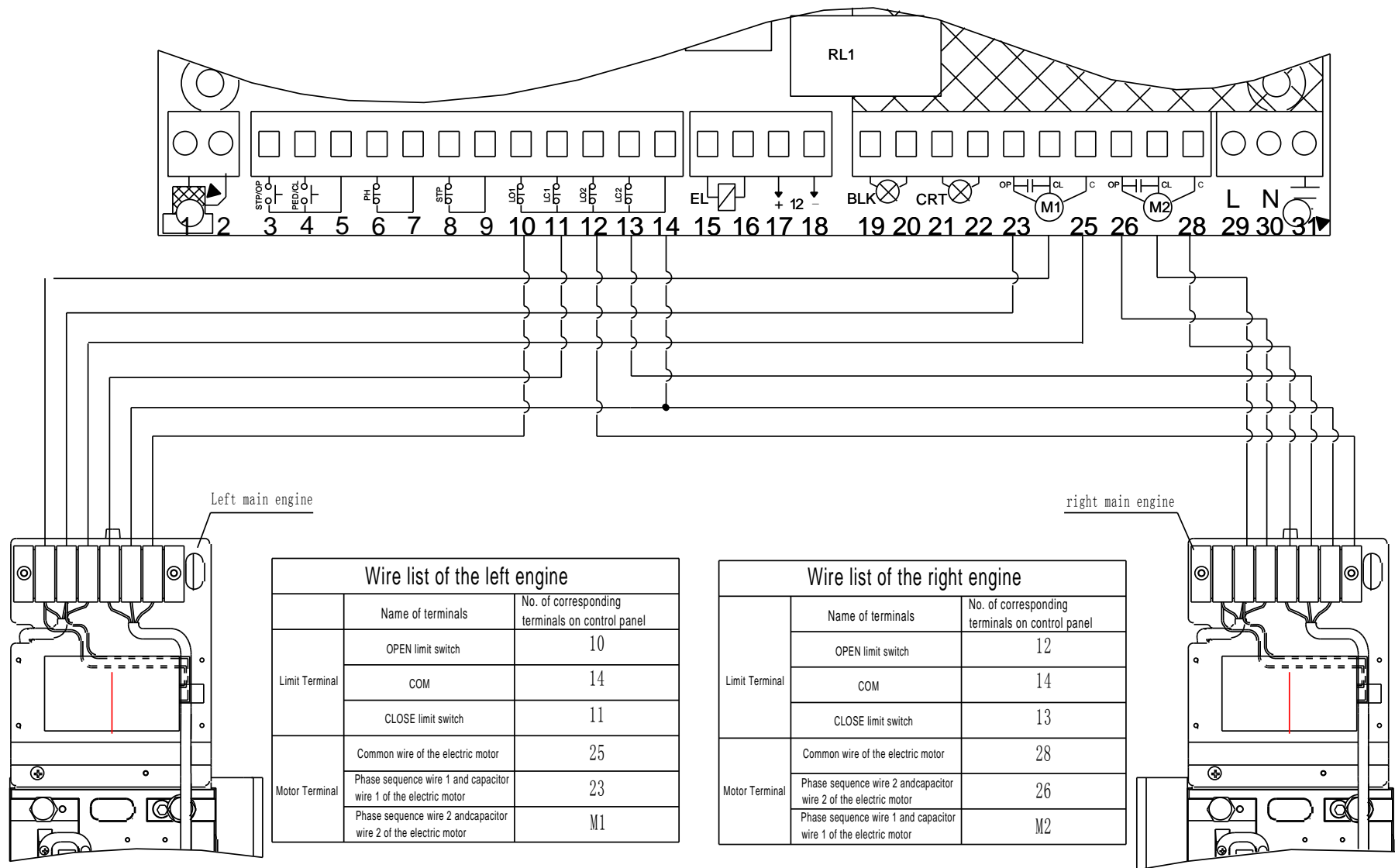

Figure 17
Wiring Scheme of the Main Engine and Control Panel

5.2 Infrared connection (Optional)

Infrared photocell function: In the closing process, when infrared ray of the infrared sensor is covered by people or objects during its detection range, the gate will open immediately for security protection.

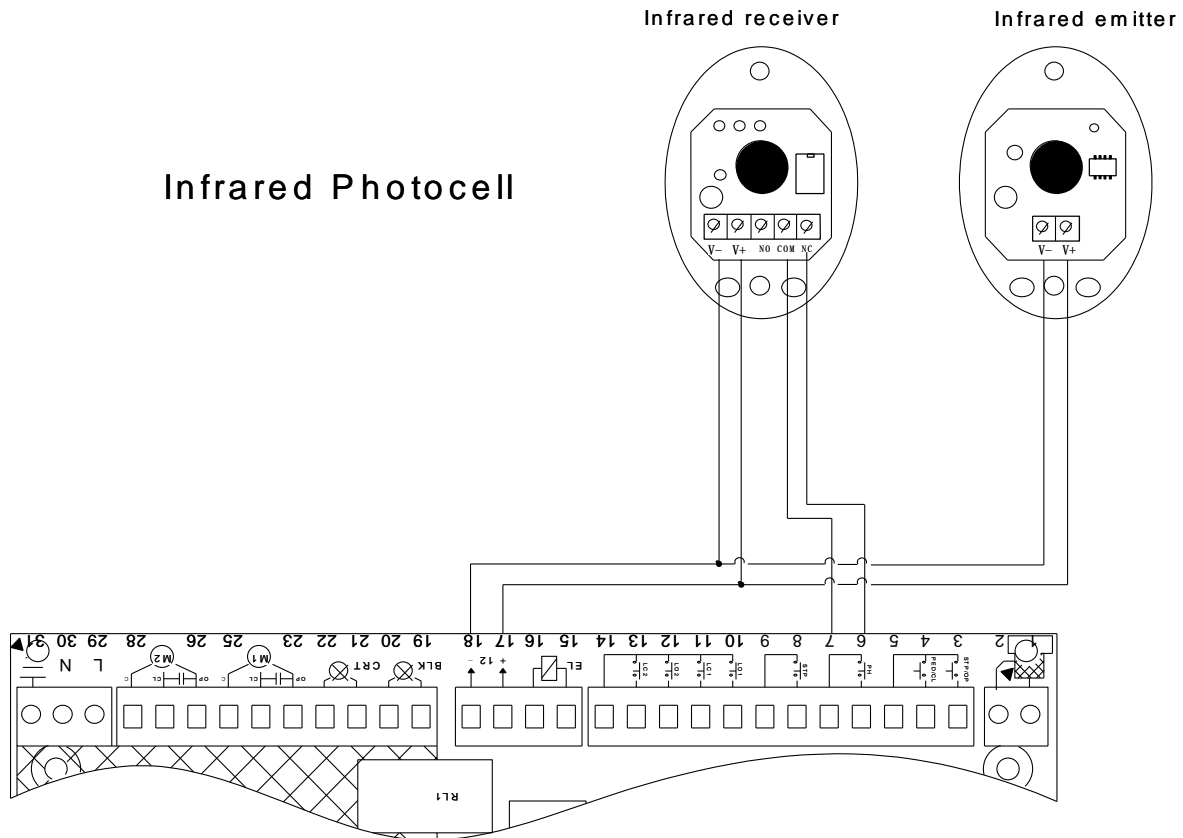

Figure 18 Wiring Scheme of Infrared

The signal of infrared terminal on the control panel is “Normal Close”; Users may choose to install the infrared photocell or not to their practical demands. Please remove the PH EXCLUSION jumper wire if the infrared photocell is connected.

The distance between photocell receiver and photocell emitter should be more than 2 meters, otherwise will affect the induction of the photocell; In addition, the outer cover of the photocell should be checked and cleaned regularly.

5.3 Wiring of alarm lamp, spotlight and electric lock (optional)

The electric lock must be installed on the gate controlled by the main engine 2.

Alarm lamp 220VAC

Spotlight 220VAC

Voltage of electric lock 12VAC
Current $\leq 1A$

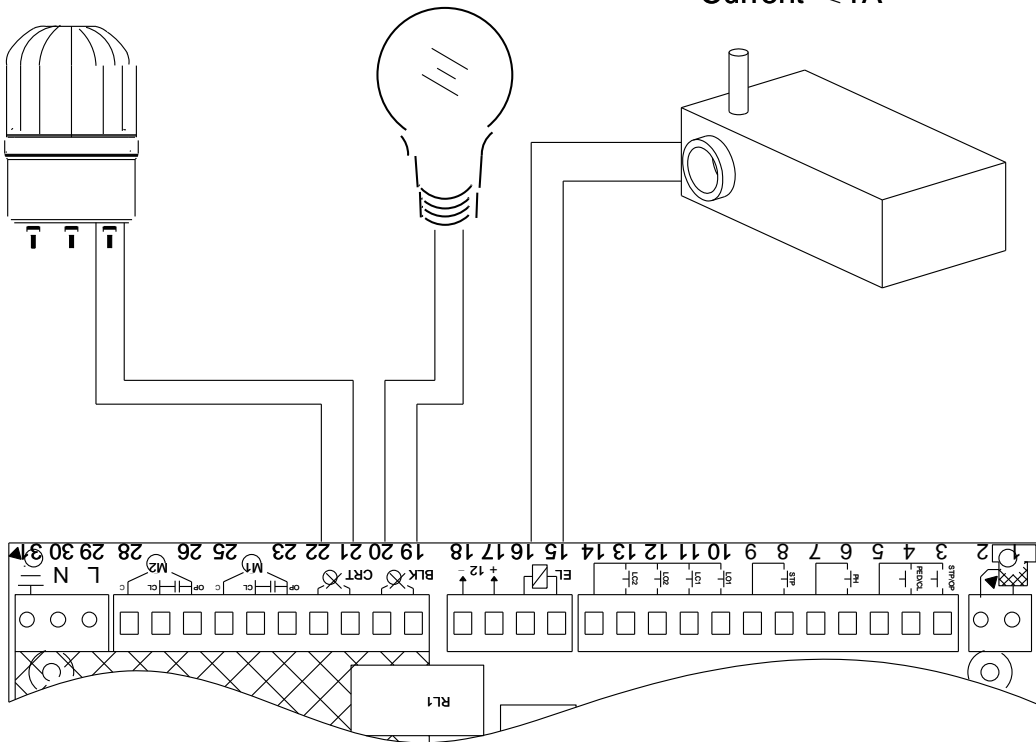

Figure 19

5.4 External button switch (Optional)

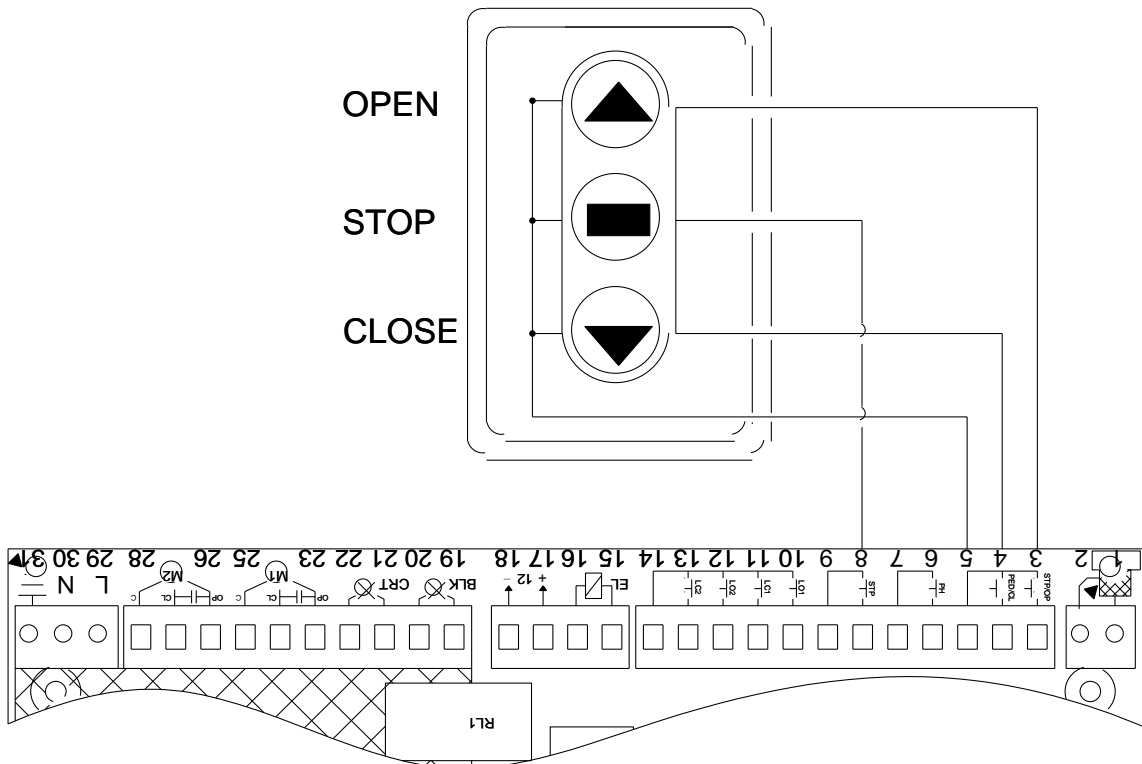

Figure 20 External button switch wiring scheme (three button mode)

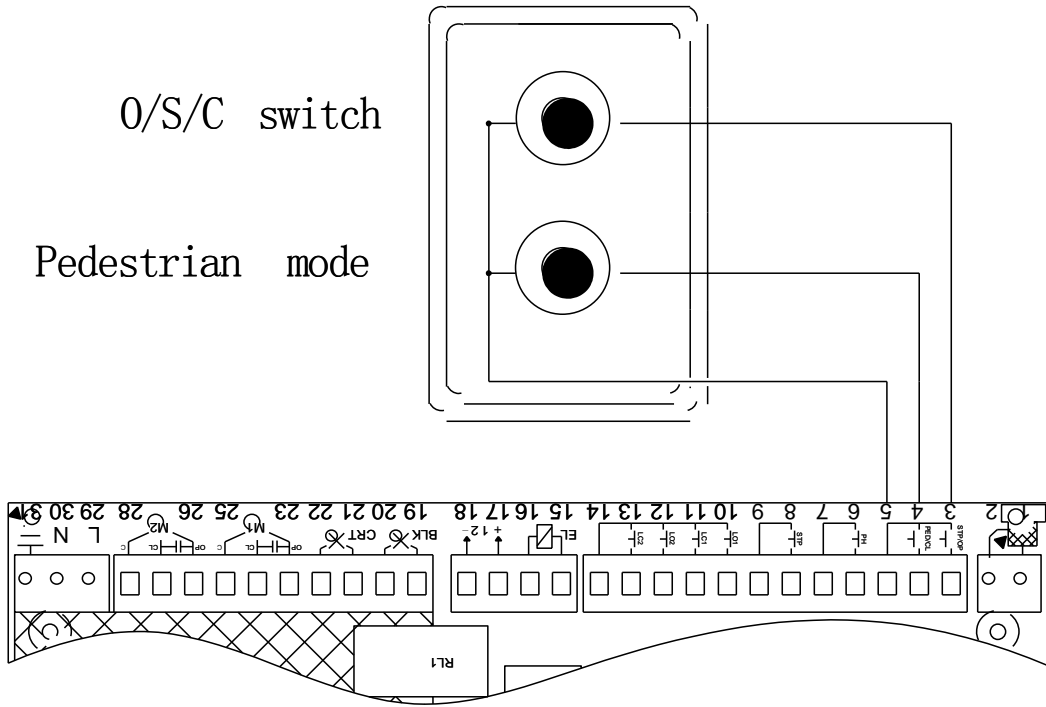

Figure 21 External button switch (single button mode)

5.5 Instruction of control panel terminals

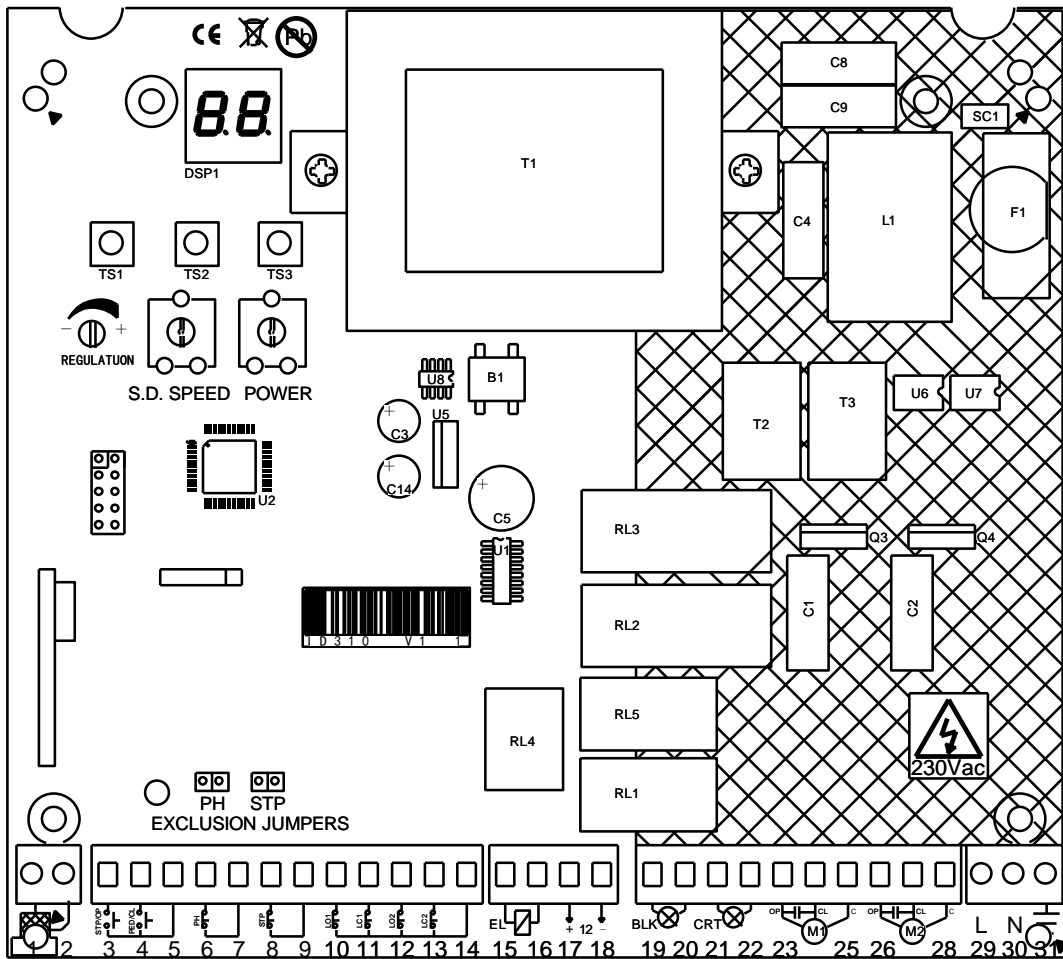

Figure 22 Instruction of control panel terminals

Receiving antenna: 1. Antenna, 2. Antenna grounded

External button switch (three button mode): 3. Door open button (Normal Open), 4. Door close button (Normal Open), 8. Stop button (Normal Open), 5. Common terminal

External button switch (single button mode): 3 Single button (Normal Open), 4 Pedestrian mode single button (Normal Open), 5. Common terminal

Infrared protective device: 6 Infrared signal input (Normal Close), 7 Common terminal

Limit of main engines: 10. OPEN limit switch of main engine 1, 11. CLOSE limit switch of main engine 1, 12. OPEN limit switch of main engine 2, 13. CLOSE limit switch of main engine 2, 14. Limit Common terminal

Output power: Output Voltage 12VDC, 17. Positive pole, 18. Negative pole

External accessories: 15-16. Electric lock (12 VAC), 19-20. Alarm lamp (220 VAC), 21-22. Spotlight (220 VAC)

Main engine's wiring:

M1 Terminal: OP main engine 1 opening line, CL main engine 1 closing line, C main engine 1 Common line

M2 Terminal: OP main engine 2 opening line, CL main engine 2 closing line, C main engine 2 Common line

Input power: 29-30. Input power (220 VAC), 31. Grounded protection

Adjusting knob:

TR1: Deceleration adjustment knob (rotate clockwise for the maximum)

TR2: Motor power adjustment knob (rotate clockwise for the maximum and the power reaches the maximum 2 seconds before motor starting)

Adjusting button:

TS1: Page up

TS3: Page down

TS2: Confirm

5.6 Quick setup (choose setting mode according to the practical installation)

a) Installed limit switch (factory default)

Limit presetting:

When the main engine is disentangled and the gate is totally closed, regulate the position of limit cam 2 (closed) to the position triggering the close gate limit switch till the gate is completely open; then regulate the limit cam 1 (open) to the position triggering open gate limit switch, adjusting method please refer to 4.3.7. After the both gates being adjusted, open the gates totally and close the disentangling mechanism.

Travel setting:

Electrify the control panel and press the TS1 button on the control panel till  shows up in the digital display; the gate controlled by the main engine 1 is being closed, so does the gate controlled by the main engine 2, both of them will stop till the gates run to the positions triggering the gate close limit. When both of the gates are closed, travel setting is completed.

Limit adjustment:

If the doors cannot be completely closed after the setting of travel, please adjust the corresponding limit cams.

b) Uninstalled limit switch

Disentangle the main engine, and then close disentangling mechanism after the two gates completely opened. Press TS1 till  shows up in the digital display.

The gate controlled by the main engine 1 starts to close and so does the gate controlled by the main engine 2. When the gate controlled by the main engine 1 is closed in place, press TS2 and the main

engine 1 stops; when the gate controlled by the main engine 2 is closed in place, press TS2 and the travel setting is completed.

5.7 Automatic learning of remote control

In order to make the remote control to be learned by the controller without opening the control cabinet, this controller is made with automatically remote control learning function. However, the following conditions should be satisfied:

- 1) Ensure there is an original (has been learned by the controller) remote control. (If without, please refer to the Basic Menu Setting—Remote control management to conduct remote control learning).
- 2) Get the automatic learning function of remote control under the advanced menu started. The new remote control and the original one have same functions. (If the original remote control can control two electric machines at the same time, so can the new one).

Operating Instructions:

Press the button on the new remote control three times continuously with each interval at least 2 seconds. After 2 seconds, press the button on the original (learned by the controller) remote control three times continuously and with each interval at least 2 seconds. When the new one is learned successfully, the alarm lamp (if there is an alarm lamp) will flash once

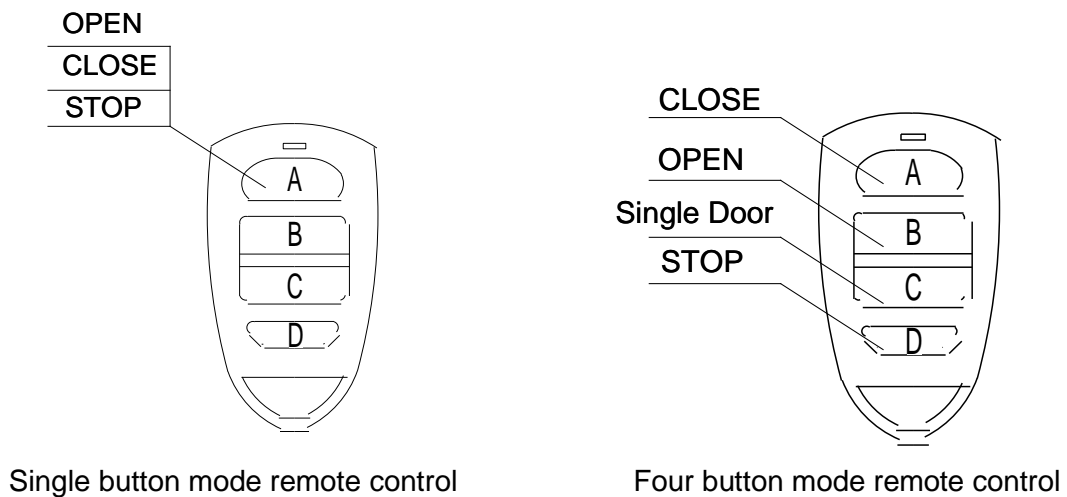











Figure 23

















5.8 Basic Setup

The basic setup is shown in Table1. Press TS2 once under standby mode. (The system will return to the normal operation mode if there is no operation within two minutes after entering into the menu)

Table 1 Basic Setup

Display	Function	Default
 <p>Resistance Sensitivity</p>	<p>Select sensitivity detection when hitting the obstacle at a normal speed, the resistance detection function will work after learning the travel.</p> <p> Cancel resistance detection function</p> <p> Adjustment of resistance sensitivity, the smaller the number is, the higher the sensitivity will be.</p> <p>When detecting the obstacle in the process of door opening, the door will reverse for 1s and stop.</p> <p>When detecting the obstacle in the process of door closing, the door will bounce back to Door-Opening in place.</p> <p>Press TS1 to increase the number, press TS3 to decrease the number.</p> <p>Press TS2 to save and quit.</p>	
 <p>Operating Mode</p>	<p> Step-by-Step mode: remote control in single button mode, open/close/stop are controlled by one button on the remote control. STR (terminal 3) controls open/close/stop. PED (terminal 4) is the single button for Pedestrian mode.</p> <p> Automatic mode: remote control in single button mode, open/close/stop are controlled by one button on the remote control, auto-close function is activation. STR (terminal 3) controls open/close/stop. PED (terminal 4) is the single button for Pedestrian mode.</p> <p> The mode for apartment: the main engine won't stop when pressing the button on remote control in gate opening process. The main engine will open the gate immediately when pressing the button on remote control in gate closing process. Activation of Auto-close function applies to crowded passageways. Open/close/stop by one button on the remote control. STR (terminal 3) controls open/close/stop. PED (terminal 4) is the single button for Pedestrian mode.</p>	











Display	Function	Default
	<p>0C Closing button mode: OP (terminal 3) is opening button, CL (terminal 4) is closing button, STP (terminal 8) is stop button. Auto-close function is activation.</p> <p>EH Quit</p>	
<p>LC Management of Remote Control</p>	<p>C1 Simultaneously control 2 main engines.</p> <p>C2 Only control 1 main engine (main engine 2).</p> <p>LL Light control.</p> <p>rE Delete the designated remote control.</p> <p>rN Delete the designated numbered remote control</p> <p>rA Delete all remote controls</p> <p>EH Exit.</p> <p>Directly operating the remote control under the corresponding states can realize the learning or deleting of remote controls. (I.e. When the digital displays C1, press the button on the remote control which needs to be learned; Digital displays the corresponding number 01, remote control learning complete.)</p> <p>Delete the designated remote control: When the digital displays rE, press the button on the remote control which needs to be deleted, digital displays re, deleting complete.</p> <p>Delete the designated numbered remote control: When the digital displays rN, press TS2, digital displays 01, press TS1、TS3 to select the number(1-40) of the remote control which needs to be deleted, press TS2 again, digital displays 45, remote control of this number is deleted.</p>	

























Display	Function	Default
	<p>Delete all remote controls: When the digital displays  press TS2, digital displays , press TS1, digital displays ; press TS2 again, digital displays , all remote controls are deleted.</p> <p>Note: Remote control in single button mode: the learned function of each button is different, so will be the number. While deleting the designated or designated numbered remote control, only one button will be deleted.</p>	
 Travel Setting	 Quick setting mode (refer to 5.7)  Manual setting mode (with one remote control which has been learned by the controller). Setting: Manually close the door first. Press confirm button TS2, digital displays  ; the two main engines open at a deceleration speed, which can be set by adjusting TR1 in the meanwhile. When the doors are fully opened, press TS2, both main engines will stop at the same time and digital displays  . Press the learned remote control and the main engine 1 starts to close; Press the TS2 once, the main engine 2 starts to close; Press the TS2 once, the main engine 1 reduces its speed; Press the TS2 once, the main engine 2 reduces its speed; Press the TS2 once, the main engine 1 stops working; Press the TS2 once, the main engine 2 stops and setting complete.	
 Automatic Close Time	<p>Make adjustments within 0 to 99 seconds according to the demands. (Only the automatic close function under Basic Menu Setting—Operating mode is enabled, did the automatic close time valid)</p> <p>Press TS1 or TS3 to adjust automatic close time. Press TS2 to save and exit.</p>	
 Manual Operation	 Door opened by the main engine 1.  Door closed by the main engine 1.  Door opened by the main engine 2.	



















Display	Function	Default
	 Door closed by the main engine 2. Select corresponding item, press and hold TS2 to realize the function of manually opening or closing the door; The main engine will stop working once TS2 is released. * Applicable to gate openers without unlocking devices.	

5.9 Advanced Menu Setting

Press and hold TS2 under the standby mode till  shows up. (The system will return to the normal operation mode if there is no operation within two minutes after entering into the menu)

Display	Function	Default
 Work Time	 Work time of the main engine 1 (the default is 30 seconds)	
	 Deceleration time of the main engine 1 (the default is 20 seconds)	
	 Work time of the main engine 2 (the default is 30 seconds)	
	 Deceleration time of the main engine 2 (the default is 20 seconds)	
	 Delayed open time for the main engine 1 when the gate is being opened (the default is 2 seconds)	
	 Delayed close time for the main engine 2 when the gate is being closed (the default is 2 seconds)	
	 Work time of spotlight (the default is 120 seconds)	
	 Work time of the electric lock (the default is 2 seconds)	
	 Exit Press TS1 and TS3 to select the items that need to be changed. Press TS2 to enter into the page for parameter modification; Then press TS1 or TS3 to change time; Press TS2 again to save and exit.	

Display	Function	Default
 Single Door Mode	 Yes  No  Exit Press TS1 or TS3 to select. Press TS2 to save and exit.	
 Reset to Defaults	 Yes  No  Exit Press TS1 or TS3 to select. Press TS2 to save and exit.	
 Disentangle of Locked-rotor	 Yes  No  Exit Press TS1 or TS3 to select. Press TS2 to save and exit. * This function is applicable to the gate openers with disengaging device. Makes it easier for clutching.	
 Remote Control Automatically Learning	 Yes  No  Exit Press TS1 or TS3 to select. Press TS2 to save and exit.	
 Reverse Push Lock	 Yes  No  Exit Press TS1 or TS3 to select. Press TS2 to save and exit. * This function is applicable to the doors installed with	

Display	Function	Default
	electric lock. Makes it easier for unlocking during door opening.	
 Soft Start	 Yes  No  Exit Press TS1 or TS3 to select. Press TS2 to save and exit.	
 Limit Switch	 Normal close limit switch  Normal open limit switch  Exit	
 Motor Series Limit Switch	 Yes  No  Exit Press TS1 or TS3 to select. Press TS2 to save and exit.	
 Remote Control Mode Switch	 Single Button Mode: Under this mode, buttons of each remote control should be learned one by one under learning menu of remote control management.  Four Button Mode: Under this mode, the function of each button on remote control is fixed. Any of the buttons is learned means all the four buttons are all learned.	

5.10 Trouble Shooting

Display	Problem	Solution
E1	Power failure	Return to factory for repair.
E2	Hitting obstacles	Check and remove the obstacle around the gate if there is.
E3	Infrared sensor ray been covered for too long (over 2 minutes), the gate is unable to work, the alarm lamp is triggered.	Check if the infrared equipment operates properly, whether there are obstacles in the middle of the door. If without, please check the infrared wiring.
E4	STOP overworking (over 2 minutes)	Check if it is connected with emergency stop equipment. If not, set this signal input into "Normal Open".

Warranty

Warranty Ordinance

1. To repair against this warranty card and invoice during the warranty period.
 2. Warranty period: 1 year after the date of invoice.
 3. Without unauthorized dismantling, any product broken or damage due to quality problem, we'll offer the repair service for free or replace for free.
 4. The malfunction and damaged caused by incorrect use or man fault is not covered by this warranty.
-

Maintenance Record

Check Date	Check Content	Maintained by